

Homey

7 COLOURS

4 SIZES

1 SURFACE

Today more than ever we perceive how important it is to have a comfortable and cozy home. Our safe place where to find peace, tranquility and love. The Homey collection is ideal to create a homey house through its warm materiality.

Homey



Residential Spaces

Technical Information

Technology & Surfaces

P. 4

P. 30

P. 32



The Homey series is inspired by the idea of obtaining natural-looking surfaces inspired by the earth, specifically clay with its warm colors and shades 'ton sur ton' obtaining a soft surface, ideal for a warm and cozy home. From the clay, pressed in established forms, then dried and fired, are created the bricks of various architectural ornaments used in construction. The Homey collection draws inspiration from these brick shapes and presents a structure in both natural and glossy finish.



Residential Spaces



COLOURS

AMBIENT

PAGINA / PAGE

Cotto / Taupe / Stripes Powder Mat	Living	6
Taupe / Cotto / Stripes White - Clay Mat	Dining	8
Chalk / Berry / Stripes Grey Mat	Kitchen	12
Flower Chalk / Stripes White Glossy	Pantry	14
Bloom Blue / Cloudy / Chalk	Bathroom	16
Bloom White / Rammed Warm	Wellness area	18
Chalk / Sage / Stripes White Mat	Bedroom	20
Cloudy / Dove	Bathroom	24
Rammed Cold / Taupe	Studio	28



Taupe / Cotto / Stripes White - Clay Mat

30x60 - 12"x24" Stripes White Mat Rettificato
30x60 - 12"x24" Stripes Clay Mat Rettificato



60x120 - 24"x48" Taupe Naturale Rettificato

60x120 - 24"x48" Cotto Naturale Rettificato



Free interpretations of original and dynamic flooring surfaces that furnish every space. The ideal floral pattern for homey and contemporary environments.



Chalk / Berry / Stripes Grey Mat



60x120 - 24"x48" Berry Naturale Rettificato
30x60 - 12"x24" Stripes Grey Mat Rettificato

60x120 - 24"x48" Flower Chalk Naturale Rettificato
60x60- 24"x24" Chalk Naturale Rettificato



Flower Chalk

60x120 - 24"x48" Flower Chalk Naturale Rettificato



Berry / Stripes White Glossy

60x120 - 24"x48" Berry Naturale Rettificato
30x60 - 12"x24" Stripes White Glossy Rettificato





Bloom White / Chalk / Cotto

60x120 - 24"x48" Bloom White Naturale Rettificato
60x120 - 24"x48" Chalk, Cotto Naturali Rettificati



Rammed Warm / Taupe

60x120 - 24"x48" Rammed Warm Naturale Rettificato
120x120 - 48"x48" Taupe Naturale Rettificato









Dove / Stripes Mustard Glossy
Cloudy / Stripes Blue Glossy

30x60 - 12"x24" Stripes Mustard Glossy Rettificato
120x120 - 48"x48" / 60x120 - 24"x48" Dove Naturale Rettificato



30x60 - 12"x24" Stripes Blue Glossy Rettificato

120x120 - 48"x48" Cloudy Naturale Rettificato



Sizes and decorations alternate and are mixed in a balanced way creating cozy environments.



Technical Information

7

Colori
Colours
Farben
Couleurs

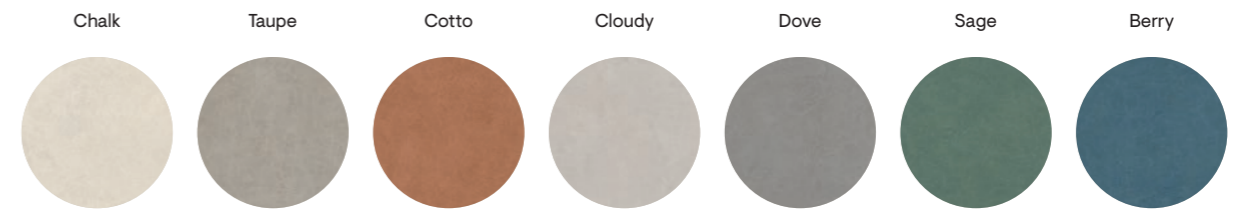

4

Formati
Sizes
Formate
Formats



1

Superfici
Surfaces
Oberflächen
Surfaces

Naturale

1

Strutture 3D
3D structures
Strukturen
Décorations en relief

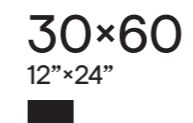

8

Colori
Colours
Farben
Couleurs



Homey has a slightly wavy and opaque texture, capable of creating surfaces that evoke the warm materiality of clay. A contemporary material with the resistance qualities of porcelain stoneware.



Glossy and mat relief structures

30x60 - 12"x24" Stripes White Mat Rettificato

30x60 - 12"x24" Stripes Blue Glossy Rettificato



Chalk

Per un risultato di posa ottimale si consiglia di prelevare le piastrelle da 5/6 scatole contemporaneamente.

For best installation results, we suggest taking the tiles from 5/6 boxes at the same time.



± 9

120×120 - 48"×48"

05245 | Homey Chalk Nat/Ret

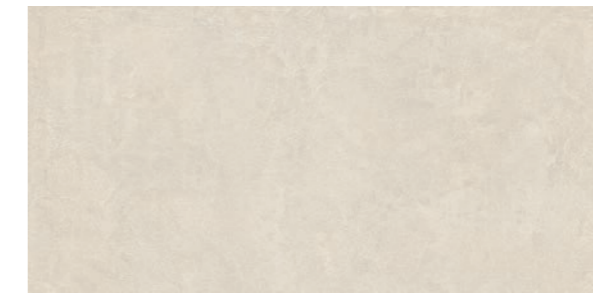

± 9,5

60×120 - 24"×48"

05216 | Homey Chalk Nat/Ret



± 9,5

60×60 - 24"×24"

05224 | Homey Chalk Nat/Ret



60×120 - 24"×48"

* **05243** | Homey Rammed Cold Nat/Ret
(mix 9 graphics)



60×120 - 24"×48"

05276 | Homey Bloom White Nat/Ret
(mix 6 graphics)

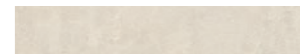

± 9,5

10×60 - 4"×24"

05277 | Homey Chalk Nat/Ret



60×120 - 24"×48"

* **05244** | Homey Rammed Warm Nat/Ret
(mix 9 graphics)

For continuity of installation, we recommend the direction of the graphics as per picture in the catalogue



Correct laying

Special pieces



Battiscopa 4,5×60 ± 9,5

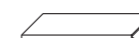

Gradino Costa Retta 33×120 ± 9,5

Taupe

For best installation results, we suggest taking the tiles from 5/6 boxes at the same time.



± 9

120×120 - 48"×48"

05248 | Homey Taupe Nat/Ret



± 9,5

60×120 - 24"×48"

05219 | Homey Taupe Nat/Ret



± 9,5

60×60 - 24"×24"

05227 | Homey Taupe Nat/Ret

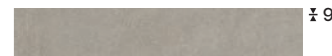

± 9,5

10×60 - 4"×24"

05280 | Homey Taupe Nat/Ret



60×120 - 24"×48"

* **05243** | Homey Rammed Cold Nat/Ret
(mix 9 graphics)

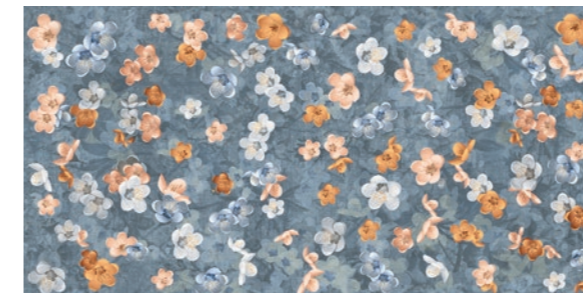

60×120 - 24"×48"

05275 | Homey Bloom Blue Nat/Ret
(mix 6 graphics)

For continuity of installation, we recommend the direction of the graphics as per picture in the catalogue



Posa corretta / Correct laying

Special pieces



Battiscopa 4,5×60 ± 9,5

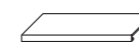

Gradino Costa Retta 33×120 ± 9,5

Cotto

For best installation results, we suggest taking the tiles from 5/6 boxes at the same time.



± 9

120×120 - 48"×48"

05249 | Homey Cotto Nat/Ret



± 9,5

60×120 - 24"×48"

05221 | Homey Cotto Nat/Ret



± 9,5

60×60 - 24"×24"

05228 | Homey Cotto Nat/Ret



± 9,5

10×60 - 4"×24"

05281 | Homey Cotto Nat/Ret



60×120 - 24"×48"

* **05244** | Homey Rammed Warm Nat/Ret
(mix 9 graphics)



60×120 - 24"×48"

05241 | Homey Flower Cotto Nat/Ret

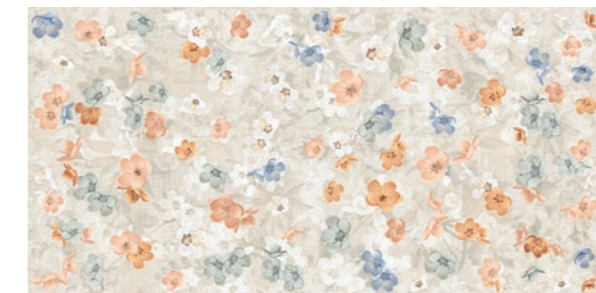

60×120 - 24"×48"

05276 | Homey Bloom White Nat/Ret
(mix 6 graphics)

For continuity of installation, we recommend the direction of the graphics as per picture in the catalogue

Special pieces



Battiscopa 4,5×60 ± 9,5

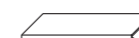

Gradino Costa Retta 33×120 ± 9,5

Cloudy

For best installation results, we suggest taking the tiles from 5/6 boxes at the same time.



£ 9

120×120 - 48"×48"

05246 | Homey Cloudy Nat/Ret

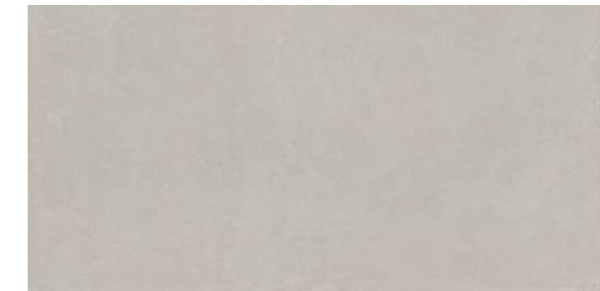

£ 9,5

60×120 - 24"×48"

05217 | Homey Cloudy Nat/Ret



£ 9,5

60×60 - 24"×24"

05225 | Homey Cloudy Nat/Ret

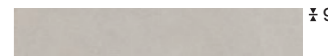

£ 9,5

10×60 - 4"×24"

05278 | Homey Cloudy Nat/Ret



60×120 - 24"×48"

* **05243** | Homey Rammed Cold Nat/Ret
(mix 9 graphics)

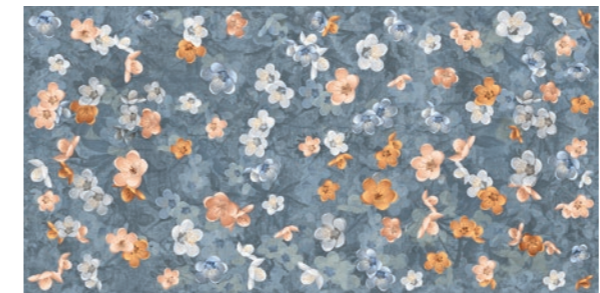

60×120 - 24"×48"

05275 | Homey Bloom Blue Nat/Ret
(mix 6 graphics)

For continuity of installation, we recommend the direction of the graphics as per picture in the catalogue

Special pieces



Battiscopa 4,5×60 £ 9,5



Gradino Costa Retta 33×120 £ 9,5

Dove

For best installation results, we suggest taking the tiles from 5/6 boxes at the same time.

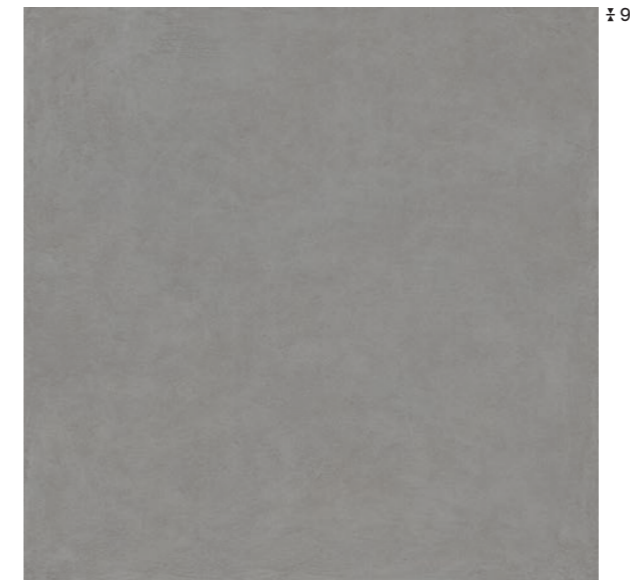

£ 9

120×120 - 48"×48"

05247 | Homey Dove Nat/Ret

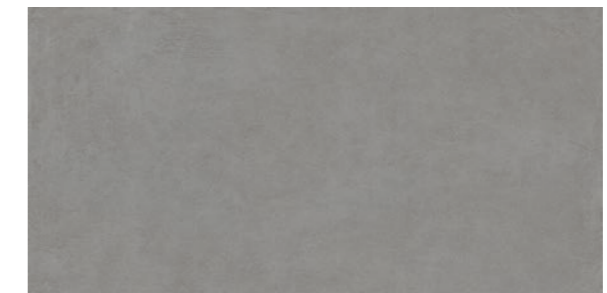

£ 9,5

60×120 - 24"×48"

05218 | Homey Dove Nat/Ret



£ 9,5

60×60 - 24"×24"

05226 | Homey Dove Nat/Ret



60×120 - 24"×48"

* **05243** | Homey Rammed Cold Nat/Ret
(mix 9 graphics)

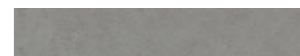

£ 9,5

10×60 - 4"×24"

05279 | Homey Dove Nat/Ret



60×120 - 24"×48"

05242 | Homey Flower Chalk Nat/Ret

For continuity of installation, we recommend the direction of the graphics as per picture in the catalogue

Special pieces



Battiscopa 4,5×60 £ 9,5

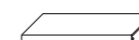

Gradino Costa Retta 33×120 £ 9,5

Sage

For best installation results, we suggest taking the tiles from 5/6 boxes at the same time.



± 9,5

60×120 - 24"×48"
05222 | Homey Sage Nat/Ret



± 9,5

60×60 - 24"×24"
05229 | Homey Sage Nat/Ret



± 9,5

10×60 - 4"×24"
05282 | Homey Sage Nat/Ret



60×120 - 24"×48"
* 05243 | Homey Rammed Cold Nat/Ret
(mix 9 graphics)



60×120 - 24"×48"
05276 | Homey Bloom White Nat/Ret
(mix 6 graphics)

For continuity of installation, we recommend the direction of the graphics as per picture in the catalogue

Special pieces



Battiscopa 4,5×60 ± 9,5

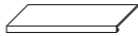

Gradino Costa Retta 33×120 ± 9,5

Berry

For best installation results, we suggest taking the tiles from 5/6 boxes at the same time.



± 9,5

60x120 - 24"x48"
05223 | Homey Berry Nat/Ret



± 9,5

60x60 - 24"x24"
05231 | Homey Berry Nat/Ret



± 9,5

10x60 - 4"x24"
05283 | Homey Berry Nat/Ret



60x120 - 24"x48"
05241 | Homey Flower Cotto Nat/Ret

Special pieces



Battiscopa 4,5x60 ± 9,5

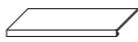

Gradino Costa Retta 33x120 ± 9,5

Homey Stripes Glossy



30x60 - 12"x24"
05234 | Homey Stripes White Glossy Ret



30x60 - 12"x24"
05235 | Homey Stripes Mustard Glossy Ret



30x60 - 12"x24"
05233 | Homey Stripes Green Glossy Ret



30x60 - 12"x24"
05232 | Homey Stripes Blue Glossy Ret

Homey Stripes Mat



30x60 - 12"x24"
05236 | Homey Stripes White Mat Ret



30x60 - 12"x24"
05237 | Homey Stripes Powder Mat Ret



30x60 - 12"x24"
05238 | Homey Stripes Clay Mat Ret



30x60 - 12"x24"
05239 | Homey Stripes Grey Mat Ret



Glossy



Mat

Matching



Stripes White Glossy



Taupe

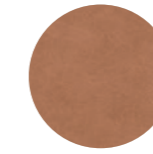

Cotto

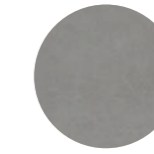

Dove

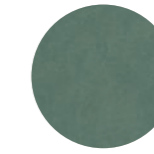

Sage

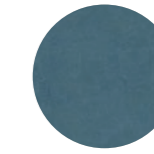

Berry



Stripes Mustard Glossy



Taupe

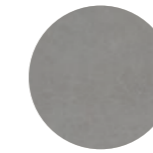

Dove



Berry



Stripes Green Glossy



Chalk



Taupe

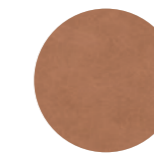

Cotto



Stripes Blue Glossy



Chalk



Taupe



Cotto



Cloudy



Stripes White Mat



Taupe



Cloudy



Dove

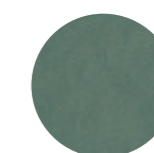

Sage



Berry



Stripes Powder Mat



Cotto



Berry

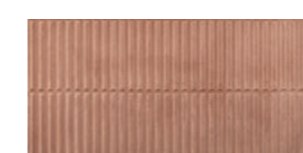

Stripes Clay Mat



Chalk



Cotto



Sage



Berry

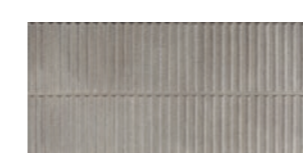

Stripes Grey Mat



Chalk



Cloudy

Collections

Recommended grouts

Formati Sizes					DIN 5130	DIN 51097	DCCF	BS EN 7976-2	AS 4586 2013	Stucchi Consigliati Recommended grouts Joints recommandés Empfohlene Fugen	
	120x120 48"x48"	60x120 24"x48"	60x60 24"x24"	10x60 4"x24"							
	ƒ 9	ƒ 9,5	ƒ 9,5	ƒ 9,5							
Nat/Ret Chalk	05245	05216	05224	05277	V2	R10	B	>0.42	wet, dry >36	P3	Mapei 111
Nat/Ret Taupe	05248	05219	05227	05280	V2	R10	B	>0.42	wet, dry >36	P3	50% Mapei 111 50% Mapei 112
Nat/Ret Cotto	05249	05221	05228	05281	V2	R10	B	>0.42	wet, dry >36	P3	Mapei 142
Nat/Ret Cloudy	05246	05217	05225	05278	V2	R10	B	>0.42	wet, dry >36	P3	Mapei 111
Nat/Ret Dove	05247	05218	05226	05279	V2	R10	B	>0.42	wet, dry >36	P3	Mapei 112
Nat/Ret Sage		05222	05229	05282	V2	R10	B	>0.42	wet, dry >36	P3	Kerakoll 19
Nat/Ret Berry		05223	05231	05283	V2	R10	B	>0.42	wet, dry >36	P3	Kerakoll 16

Stucchi Consigliati
 Recommended grouts
 Joints recommandés
 Empfohlene Fugen

Decori Decors						
	Flower Cotto 60x120 24"x48"	Flower Chalk 60x120 24"x48"	Rammed Warm 60x120 24"x48"	Rammed Cold 60x120 24"x48"	Bloom White 60x120 24"x48"	Bloom Blue 60x120 24"x48"
	ƒ 9,5	ƒ 9,5	ƒ 9,5	ƒ 9,5	ƒ 9,5	ƒ 9,5
		05242	05244	05243	05276	05275
			05244	05243		05275
	05241		05244	05243	05276	
				05243		05275
		05242		05243	05276	05275
		05242			05276	
	05241					

Kerakoll 34	Mapei 111	Mapei 133	Mapei 111	Mapei 111	Kerakoll 14
-------------	-----------	-----------	-----------	-----------	-------------

Strutture 3D 3D Structures								
	Stripes White Glossy 30x60 12"x24"	Stripes Mustard Glossy 30x60 12"x24"	Stripes Green Glossy 30x60 12"x24"	Stripes Blue Glossy 30x60 12"x24"	Stripes White Mat 30x60 12"x24"	Stripes Powder Mat 30x60 12"x24"	Stripes Clay Mat 30x60 12"x24"	Stripes Grey Mat 30x60 12"x24"
	ƒ 9,5	ƒ 9,5	ƒ 9,5	ƒ 9,5	ƒ 9,5	ƒ 9,5	ƒ 9,5	
Nat/Ret Chalk			05233	05232			05238	05239
Nat/Ret Taupe	05234	05235	05233	05232	05236			
Nat/Ret Cotto	05234		05233	05232		05237	05238	
Nat/Ret Cloudy				05232	05236			05239
Nat/Ret Dove	05234	05235			05236			
Nat/Ret Sage	05234				05236		05238	
Nat/Ret Berry	05234	05235			05236	05237	05238	

Stucchi Consigliati
 Recommended grouts
 Joints recommandés
 Empfohlene Fugen

Mapei 111	Kerakoll 30	50% Kerakoll 19 50% Mapei 120	Kerakoll 16	Mapei 111	Mapei 141	Kerakoll 34	Kerakoll 112
-----------	-------------	----------------------------------	-------------	-----------	-----------	-------------	--------------

Pezzi Speciali Special Pieces	
Gradino Costa Retta 33x120 13"x48"	Battiscopa 4,5x60 1 3/4"x24"
ƒ 9,5	ƒ 9,5
05264	05256
05267	05259
05268	05261
05265	05257
05266	05258
05269	05262
05271	05263

Formati Sizes		± MM	 Pezzi Scatola Pieces/Box Stck/Karton Carreaux/Boîte	 Mq/Scatola Sqmt/Box Qm/Karton M2/Boîte	 Kg/Scatola Kgs/Box Kg/Karton Kg/Boîte	 Scatole/Paletta Boxes/Pallet Karton/Palette Boîte/Palette	 Mq/Paletta Sqmt/Pallet Qm/Palette M2/Palette	 Kg/Paletta Kgs/Pallet Kg/Pallet Kg/Palette	 Formato Paletta Size Pallet Format Pallet Dim. Palette
120x120 (48"x48") Nat/Ret	P	9	2	2,880	58,00	22	63,36	1276,00	143x126x67
60x120 (24"x48") Nat/Ret	P	9,5	2	1,440	31,00	30	43,20	930,00	120x80x96
60x60 (24"x24") Nat/Ret	P	9,5	4	1,440	29,00	32	46,08	928,00	120x80x75
10x60 (4"x24") Nat/Ret	P	9,5	10	0,600	12,50	72	43,20	900,00	120x80x75
30x60 (12"x24") Stripes Nat/Ret	P	9,5	7	1,260	26,30	32	40,32	841,60	120x80x75
60x120 (24"x48") Rammed Nat/Ret	P	9,5	2	1,440	31,00	30	43,20	930,00	120x80x96
60x120 (24"x48") Bloom Nat/Ret	P	9,5	2	1,440	31,00	30	43,20	930,00	120x80x96
60x120 (24"x48") Flower Nat/Ret	P	9,5	2	1,440	31,00	30	43,20	930,00	120x80x96

Pezzi Speciali / Special Pieces

33x120 (13"x48") Gradino Costa Retta Nat/Ret	P	9,5	2	0,792	18,50	20	-	-	-
4,5x60 (1¾"x24") Battiscopa Nat/Ret	P	9,5	14	0,378 m.l. 8,40	8,00	80	-	-	-

All sizes are nominal.

The thickness mentioned on this catalogue are nominal and can be different according to the sizes and the finishes.

The colours and appearance features of the products are as close as possible to reality, within the limitation of the printing process.

Battiscopa Nat/Ret 4,5x60 – 1¾"x24" ± 9,5

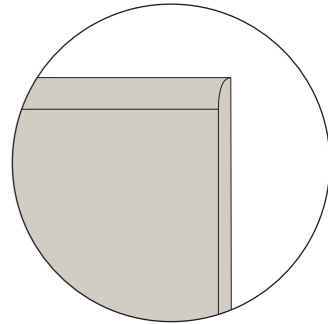
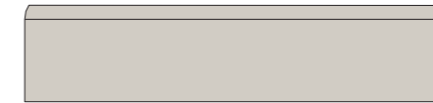

Gradino Costa Retta Nat/Ret 33x120 – 13"x48" ± 9,5

(costa retta ottenuto per taglio e incollaggio - obtained by cutting and gluing)

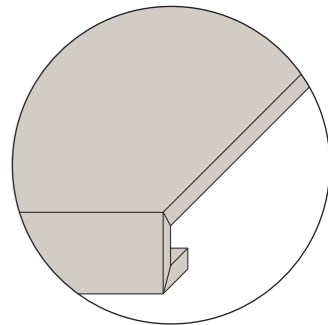
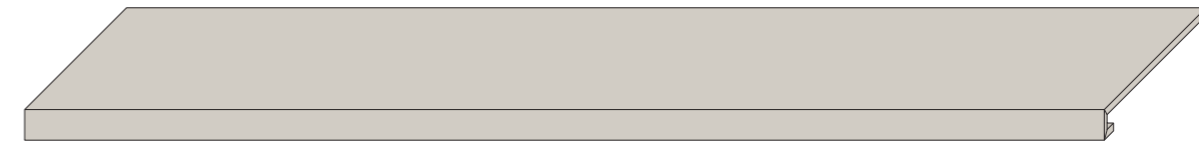

Installation and maintenance instructions

- For better installation results of rectified products, we suggest 2 mm joint.
- For a better aesthetic finish, Piemme recommends using jointing colours that match the tiles.
- Please check, before using, the compatibility and suitability of grouting material with the ceramic tile.
- Clean away the excess of grouting materials while they are still fresh.
- Follow carefully the instructions pointed out by the producers of tile grouting materials.
- To completely eliminate installation residues, which could negatively affect routine maintenance and product characteristics once installation has terminated, proceed to clean using adequate products, with max. 3% Acid base, following the manufacturer's instructions. Always closely abide by the time limits indicated in the instructions: prolonged contact with these products may cause damage to the surface.
- Any rims that appear after installing lapped or polished materials can be easily eliminated using a suitable Alkaline-based product.
- With regard to the use of ceramic materials outdoors, while once more reiterating that Piemme porcelain stoneware products are frost-proof, in compliance with applicable European standards EN 14411/ISO 13006-ISO 10545.12, a number of fundamental procedures must be followed for outdoor installation, suitable for making the aforementioned floors resistant to frost. The most important aspects are: suitable gradients, waterproofing, expansion joints, and the use of suitable installation materials.
- Decorations made with glazes and precious metals it is most important to protect the surface during installation. Never use abrasive and/or acid products, only water and neutral soap. The manufacturer disclaims liability in case of any damage to these precious materials caused by "rubbing" during installation. Under no circumstances will disputes be accepted relating to the installed material.











TIPO DI SPORCO	INDICAZIONI PER LA PULIZIA
Birra, Caffè, Gelato, Vino Gomma Pneumatico, Grassi vegetali e animali, Inchiostri, Lampostil Olii Meccanici, Residui di scotch Olio di lino, PennarellorResine Smalti, Tintura per capelli	Prodotti a Base Alcalina
Cera protettiva anti-abrasione, Depositi calcarei, Macchie di ruggine	Prodotti a Base Acida
Cera di candela, Residui di scotch	Solventi
Per ulteriori informazioni specifiche consultare l'area tecnica sul sito Piemme: www.ceramichepiemme.it	

TYPE OF STAIN	CLEANING SUGGESTIONS
beer, coffee, wine, ice cream vegetable and animal fats, rubber, remains of scotch tape, grease from machines, linseed oil, felt tip pens, paints, inks, hair dye	Alkaline-based detergent
protective anti-abrasion wax, calcareous residuals, rust stains	Acid-based detergent
candle wax, remains of scotch-tape	Solvents

For further specific details please visit the technical area on Piemme website: www.ceramichepiemme.it

Technical Characteristics

CLASSIFICAZIONE SECONDO NORME EN 14411 BI_A – ISO 13006 - CLASSIFICATION IN ACCORDANCE WITH EN 14411 BI_A – ISO 13006
 KLASIFIZIERUNG GEMÄSS NORMEN EN 14411 BI_A – ISO 13006 - CLASSIFICATION SELON LES NORMES EN 14411 BI_A – ISO 13006

	TECHNICAL CHARACTERISTIC	NORM	VALUE REQUIRED	MEAN VALUE	NORM	MEAN VALUE		
	LUNGHEZZA E LARGHEZZA LENGTH AND WIDTH / LÄNGE UND BREITE / LONGUEUR ET LARGEUR		±0.6% (±2.00 MM)					
	SPESORE THICKNESS / STÄRKE / EPAISSEUR		±5% (±0.5 MM)					
	RETTILINEITÀ LATI WARPAGES OF EDGES / GERADHEIT DER KANTEN / RÉCTITUDE DES ARÊTES	ISO 10545.2	±0.5% (±1.5 MM)	CONFORME IN ACCORDANCE ERFÜLLT CONFORME	ASTM C-499 ASTM C-485 ASTM C-502	IN ACCORDANCE		
	ORTOGONALITÀ WEDGING / RECHTWINKLIGKEIT / ORTHOGONALITÉ		±0.5% (±2.00 MM)					
	PLANARITÀ FLATNESS / PLANITÄT / PLANIMÉTRIE		±0.5% (±2.00 MM)					
	ASSORBIMENTO % D'ACQUA WATER ABSORPTION WASSERAUFNAHME % ABSORPTION D'EAU %	ISO 10545.3	≤ 0.5%	CONFORME IN ACCORDANCE ERFÜLLT CONFORME	ASTM C-373	IN ACCORDANCE		
	RESISTENZA ALLA FLESSIONE BENDING STRENGTH BIEGEZUGFESTIGKEIT RÉSISTANCE À LA FLEXION	ISO 10545.4	Modulus of rupture (average): R ≥ 35N/mm ² Breaking strength for thickness ≥ 7.5 mm S > 1300 N	CONFORME IN ACCORDANCE ERFÜLLT CONFORME	ASTM C-648 250 LBS OR GREATER	IN ACCORDANCE		
	DILATAZIONE TERMICA LINEARE TRA 20° E 100° C LINEAR THERMAL EXPANSION BETWEEN 20° AND 100° C LINEARE WÄRMEAUSSDEHNUNG ZWISCHEN 20° UND 100° C DILATATION THERMIQUE LINEAIRE ENTRE 20° ET 100° C	ISO 10545.8	SECONDO I DATI DEL COSTRUTTORE ACCORDING TO BUILDER'S SPECIFICATIONS LAUT ANGABEN DES HERSTELLERS SELON LES ELEMENTS DU COSTRUCTEUR		= 7X10 ⁻⁶ C ⁻¹			
	RESISTENZA AGLI SBALZI TERMICI THERMAL SHOCK RESISTANCE TEMPERATURWECHSELBESTÄNDIGKEIT RÉSISTANCE AUX ÉCARTS DE TEMPÉRATURE	ISO 10545.9	RICHIESTA REQUEST BITTE DEMANDE	RESISTENTE RESISTANT WIDERSTEHEND RÉSISTANT				
	RESISTENZA AL GELO FROST RESISTANCE FROSTBESTÄNDIGKEIT RÉSISTANCE AU GEL	ISO 10545.12	RICHIESTA REQUEST BITTE DEMANDE	RESISTENTE RESISTANT WIDERSTEHEND RÉSISTANT	ASTM C-1026	IN ACCORDANCE		
	RESISTENZA ALL'ATTACCO CHIMICO RESISTANCE TO CHEMICAL ATTACK BESTÄNDIGKEIT GEGEN CHEMIKALIEN RÉSISTANCE À L'ATTAQUE CHIMIQUE	ISO 10545.13	SECONDO I DATI DEL COSTRUTTORE ACCORDING TO BUILDER'S SPECIFICATIONS LAUT ANGABEN DES HERSTELLERS SELON LES ELEMENTS DU COSTRUCTEUR	RESISTENTE RESISTANT WIDERSTEHEND RÉSISTANT	ASTM C-650	IN ACCORDANCE		
	RESISTENZA DEI COLORI ALLA LUCE COLOURS RESISTANCE TO LIGHT LICHTBESTÄNDIGKEIT RÉSISTANCE DES COULEURS À LA LUMIÈRE	DIN 51094	NESSUNA ALTERAZIONE NO ALTERATION KEINE VERÄNDERUNG AUCUNE ALTÉRATION	CONFORME IN ACCORDANCE ERFÜLLT CONFORME				
	RESISTENZA ALLE MACCHIE STAIN RESISTANCE FLECKENFESTIGKEIT RÉSISTANCE AUX TACHES	ISO 10545.14	≥ CLASSE 3 METODO DI PROVA DISPONIBILE TEST METHOD AVAILABLE VERFÜGBARE PRÜFMETHODE METHODE D'ESSAI DISPONIBILE	CONFORME IN ACCORDANCE ERFÜLLT CONFORME				
	RESISTENZA ALLO SCIVOLAMENTO SLIPPAGE RESISTANCE RUTSCHSICHERHEIT RÉSISTANCE AU GLISSEMENT	DIN 51130 *	9 ≤ R ≤ 13	NAT	R10	ASTM C-1028 * COF	NAT	
		DIN 51097 *	A,B,C			≥ 0.6 DRY ≥ 0.6 WET		
					B	ANSI * 137.1-2012 DCOF	NAT	> 0.42
					Wet, Dry > 36		NAT	P3
	PENDULUM SLIP TEST	BS EN 7976-2*	> 36 DRY > 36 WET			AS 4586: 2013		
						CLASS		

INDUSTRIE CERAMICHE PIEMME S.P.A., PUÒ VARIARE IN BASE AL LOTTO PRODUTTIVO. SPECIFICA DOCUMENTAZIONE È DISPONIBILE SU RICHIESTA.
 TEST METHODS, REQUIREMENTS AND CLASSIFICATIONS DIFFER FROM COUNTRY TO COUNTRY, ACCORDING TO THE NATIONAL REGULATIONS. THE EXPECTED VALUE OF SLIPPAGE RESISTANCE OF PRODUCTS BY
 INDUSTRIE CERAMICHE PIEMME S.P.A. MAY VARY DEPENDING ON THE PRODUCTION BATCH. SPECIFIC DOCUMENTS ARE AVAILABLE UPON REQUEST.
 PRÜFVERFAHREN, ERFORDERNISSE UND KLASIFIKATIONEN SIND VERSCHIEDEN VON LAND ZU LAND, GEMÄSS DER NATIONALEN VORSCHRIFTEN. DER ERWARTUNGSWERT DER RUTSCHSICHERHEIT DER PRODUKTE VON
 INDUSTRIE CERAMICHE PIEMME S.P.A. KANN SICH - JE NACH DER PRODUKTIONSPARTIE - VERÄNDERN. SPEZIFISCHE UNTERLAGEN SIND AUF VERLANGEN ZUR VERFÜGUNG.
 LES MÉTHODES D'ESSAI, LES RÉQUISITIONS ET LES CLASSIFICATIONS CHANGENT DE PAYS À PAYS, SELON LES RÉGLEMENTATIONS NATIONALES. LA VALEUR ATTENDUE DE RÉSISTANCE AU GLISSEMENT
 DES PRODUITS DE INDUSTRIE CERAMICHE PIEMME S.P.A. PEUT VARIER EN FONCTION DU LOT DE PRODUCTION. UNE DOCUMENTATION SPÉCIFIQUE EST DISPONIBILE SUR DEMANDE.

ELENCO DELLE SERIE CERTIFICATE E CLASSIFICAZIONI DISPONIBILI A RICHIESTA - LIST OF CERTIFIED SERIES AND CLASSIFICATIONS AVAILABLE UPON REQUEST
 LISTE DER GEPRÜFTEN SERIE UND KLASIFIZIERUNGEN AUF ANFRAGE ERHÄLTICH - LISTE DES SERIES CERTIFIÉES ET DES CLASSEMENTS DISPONIBLES SUR DEMANDE





THORNTREE

natural stone • fine porcelain